



„Excitingly detailed“

The MODIS FIVE 240 is, in the tradition of the proven notebook-like MODIS products, a retractable (touch) monitor, which is installed in meeting tables and integrates perfectly into the room design.

The milled aluminum screen is 15mm slim and coated white. It has a black glass front, carbon applications and an all-round, filigree decorative milling. The screen is reduced to the necessary and fascinatingly beautiful in its functional design.

The heart of the MODIS FIVE 240 is its electric motor drive, which allows the screen to open as quietly as a whisper, like a notebook. Once the screen is open, a keyboard tray automatically rises to provide the user with a complete work system. The screen has a diagonal of 23.8 inches and ensures a razor-sharp display, optionally in FullHD or UHD resolution.

The stepper motors provide precise control of the movement and guarantee a long service life as well as high reliability.

The unique mechanism folds flat into the table and the rear of the panel may also be veneered with the matching surface material: Glass, Corian, Leather – the choice is yours.

MODIS FIVE 240



„Collaboration Device“

Optionally, the **MODIS FIVE 240** can be equipped with a touch interface and a high-resolution video camera. This further increases user productivity and expands the possibilities of presentation technology.

The **MODIS FIVE 240** is an innovative and elegant piece of AV media technology that fits perfectly into the modern meeting environment

Features

- Slim monitor housing aluminum, powder-coated RAL 9006 white aluminium, Carbon cover trim inlay
- 2 mm tempered & anti-reflective protective cover glass
- Low installation depth ensures ergonomical knee / legroom below the table installed screen
- Coatable rearside
- LightWeight, LowNoise, LowEnergyDesign
- HDMI HDCP compliant
- FullHD resolution
- 5 years limited warranty
- 2x stepper motors 12V & precise mechanics
- Electronic clamping protection plus mechanical protection in case of incorrect operation
- Optionally with a variety of additional functions expandable, such as camera, touch screen, connector ...



FEATURES

MODIS FIVE 240



TECHNICAL DATA

Product Specification



Art.No. Type	304-240 Full HD MODIS 240-5 FullHD	Screen size:	23.8" (16:9)
Function	In furniture integratable 23.8" monitor system; Lifting mechanism with two individual motors for extending / retracting monitor and front panel (notebook-type motion - operation side in closed state below, steplessly controllable at the push of a button on the device or via the remote control interface). Control via push-button on the device or via remote control interfaces (TCP / IP or dry contact). Low noise <40dB; two 12V stepper motors with precise synchronization - for simultaneous extension when using multiple monitors; independent electromotive adjustment of the inclination angle - both central presetting via remote interface as well as individual adjustment by user.	Resolution:	1,920 x 1,080 - Full HD, 16.7M colors (6bit + A-FRC)
Material	Monitor: Milled aluminum, powder-coated RAL 9006 white aluminium - metallic fine structure - matt; 2mm-reflective safety glass, black Cover Trim on the frontside: Carbon Fibre Mechanics: Anodized aluminum, stainless steel Mounting Frame Stainless steel, powder-coated RAL 9006 white aluminium - metallic fine structure - matt Front Plate / Keyboard Plate: Artificial leather	Brightness:	250 cd/m ²
		Contrast ratio:	(typ.) 1,000:1
		Viewing angle:	Horizontal 178° / vertical 178°
		Viewing area:	527.04 (H) x 296.46 (V) mm
		Pixel size:	0.2745 x 0.2745 mm
		LED Lifespan:	up to 30,000 hrs.
		Mass:	16 kg
		Dimensions:	585 x 440 x 64/86 mm (WxLxD front / T rear); Monitor thickness: 25mm
		Power consumption:	typ. 20 W
		P. consumption Monitor:	OFF: 0.12 W, Sleep: 0.60 W, ON: 18.4 W
		Inclination angle max.:	20°
		Appearance h. Monitor:	341mm at 20°
		2x Stepper Motors:	Display Motion & Front plate* (*not supplied w. Basic-Version)
		Video Interface:	HDMI, Displayport *, DVI **; HDCP compliant
		Remote Interface:	9-pin d-sub serial + RJ45/ TCP/IP for control and adjustment of motion parameter, also Firmware Update (E1-Cable & Software required)
		Scope of Supply:	Power adapter - Input: 100-240V AC, 50 / 60Hz. 1.5A; Output: 12V 60W MAX 5.A (Length DC ~ 140cm) Power Cord 1.5m

* optionally, additional Interface | ** optionally, instead of HDMI

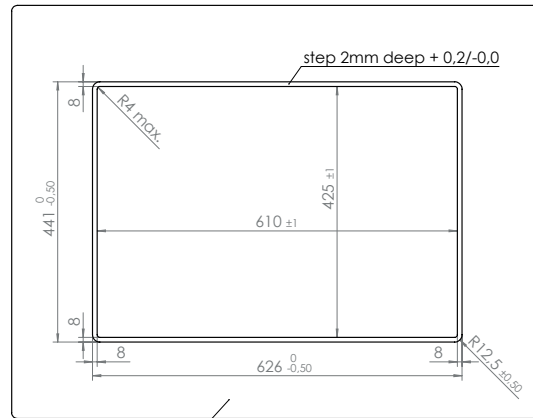
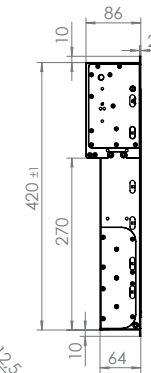
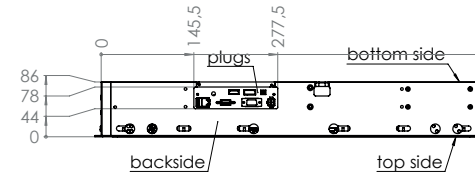
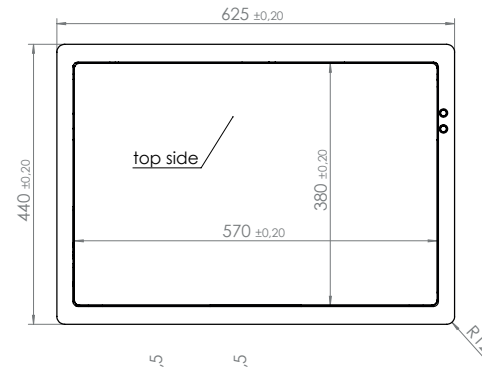
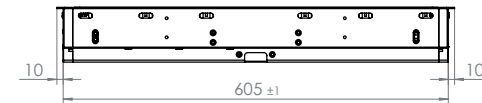
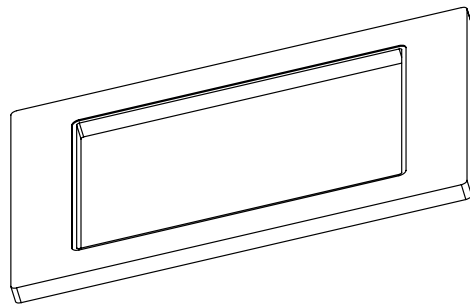

table top-side



ickzahl 1

Dimensions

We'd be delighted to offer our expertise in the planning and selection of the right solution for your needs. If required, we can send further technical drawings, detailed photographs, material samples and, of course, demo devices – perfect to handle and try out.

Simply call us on **+49 (0)7222 96654-20**

Or send us an e-mail at: **info@element-one.de**

ELEMENT ONE

Multimedia GmbH

Zum Murgdamm 5

76456 Kuppenheim

Germany

Fon: +49 (0) 7222 966 54 20

Mail: info@element-one.de

www.element-one.de